

• Rodea los elementos que te indica el número. Escríbelo

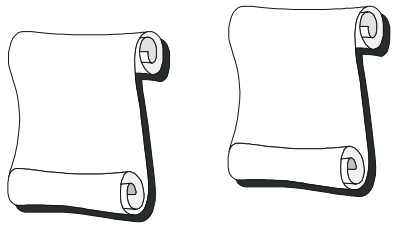

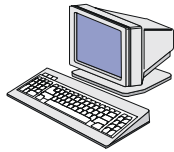

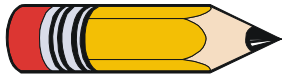



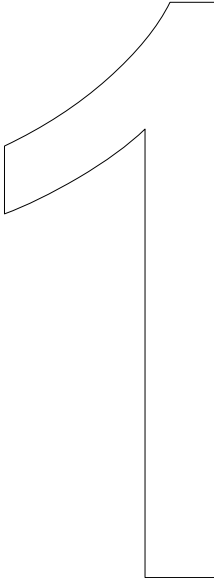

uno

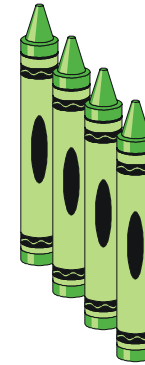



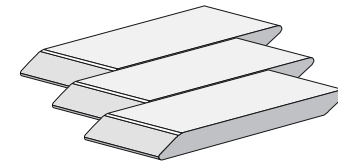

Nombre: Fecha:

● Rodea los elementos que te indica el número. Escríbelo

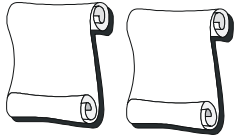



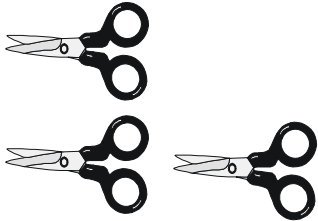

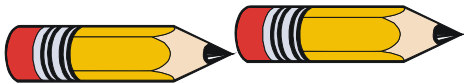

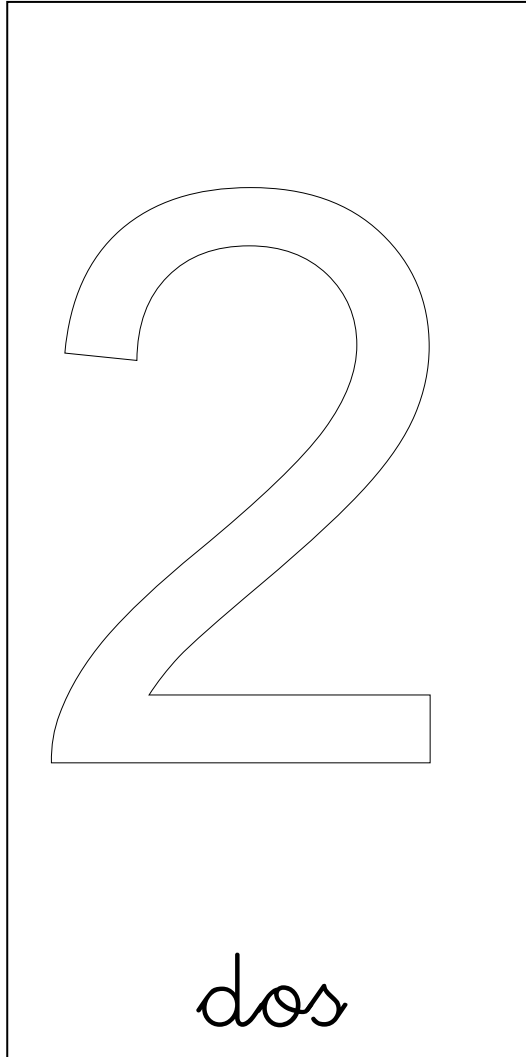

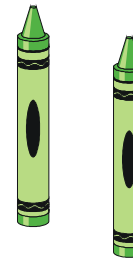

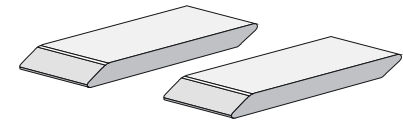

Nombre: Fecha:

● Rodea los elementos que te indica el número. Escríbelo.







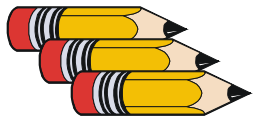

tres

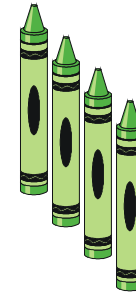

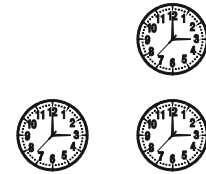

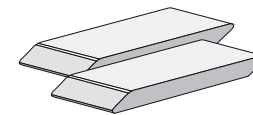

Nombre: Fecha:

● Rodea los elementos que te indica el número. Escríbelo.



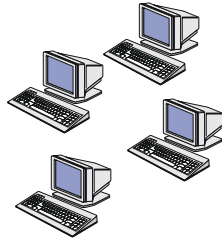

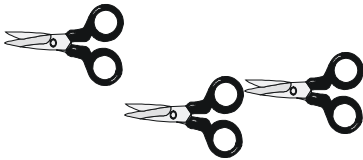

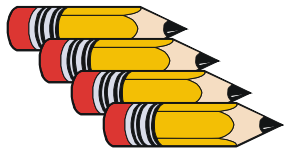

cuatro

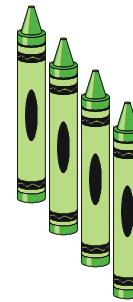



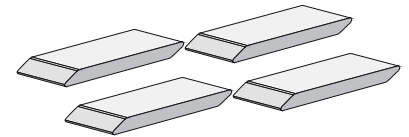

Nombre: Fecha:

● Rodea los elementos que te indica el número. Escríbelo.

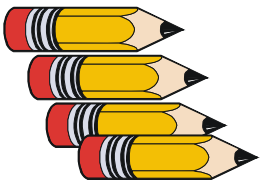
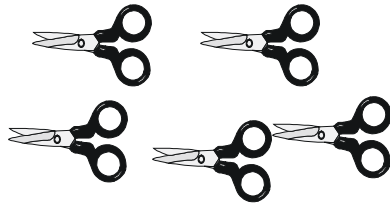
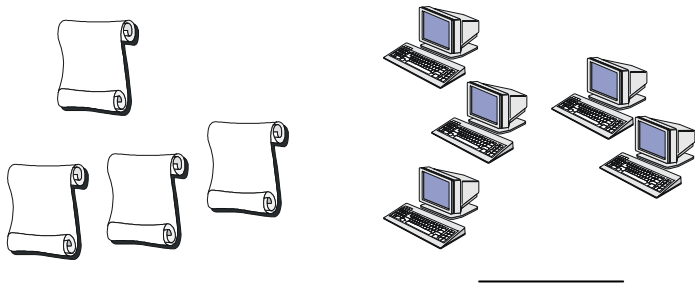

cinco

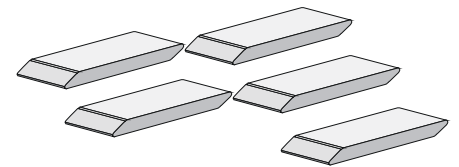
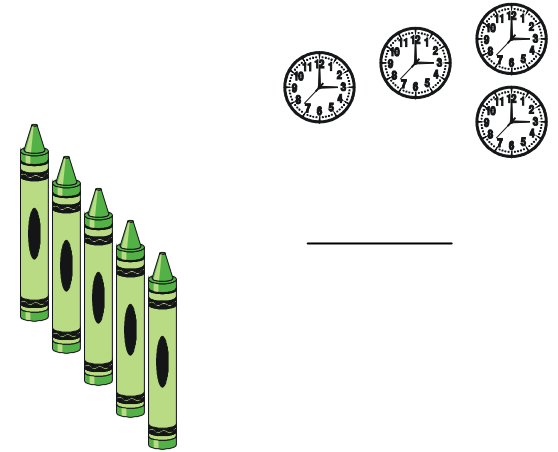

Nombre:

Fecha:

● Rodea los elementos que te indica el número. Escríbelo.

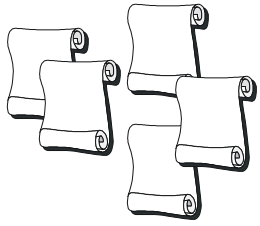

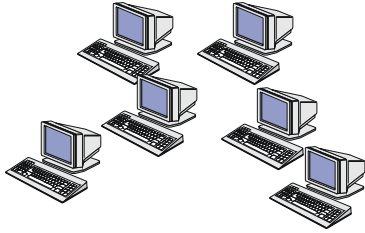



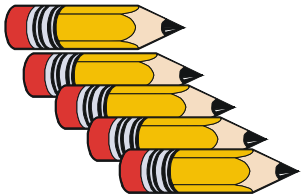

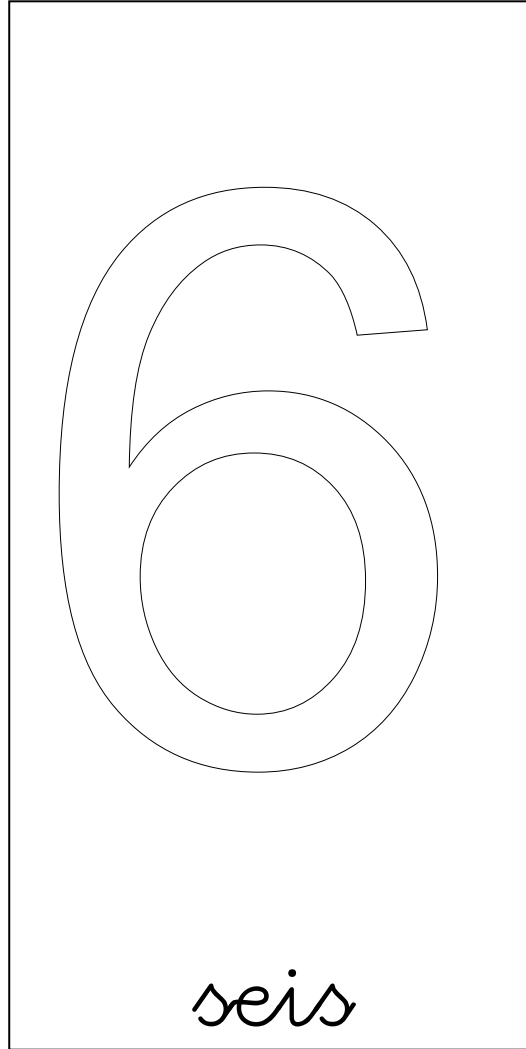

seis

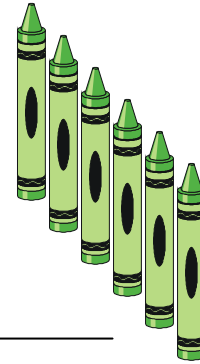

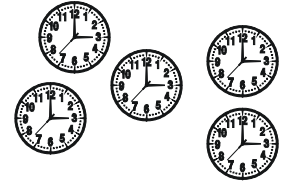

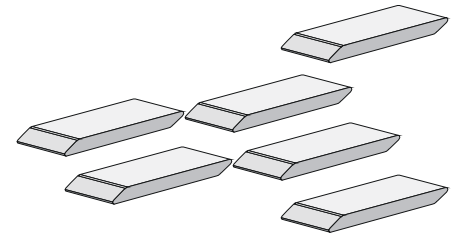

Nombre: Fecha:

● Rodea los elementos que te indica el número. Escríbelo.

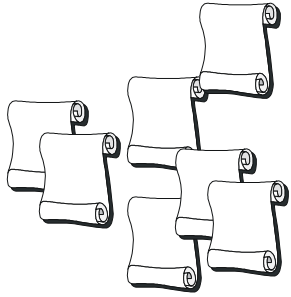

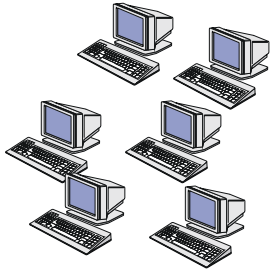



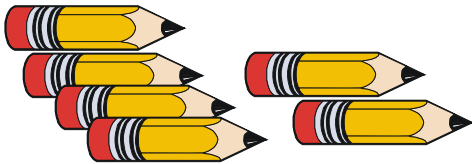

siete

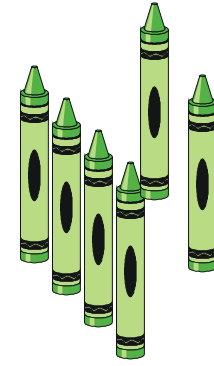

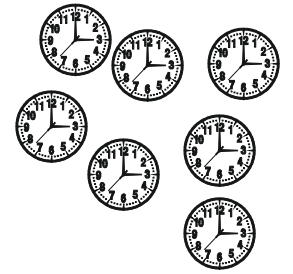

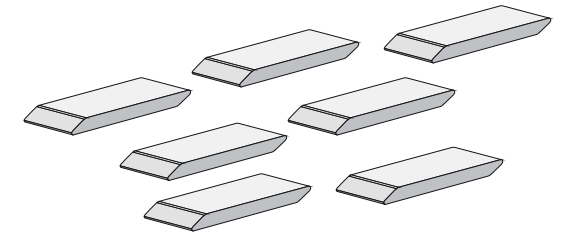

Nombre: Fecha:

● Rodea los elementos que te indica el número. Escríbelo.

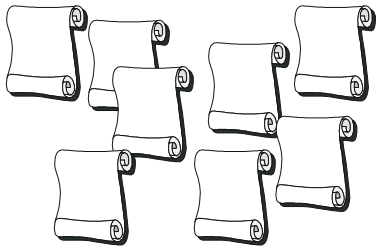

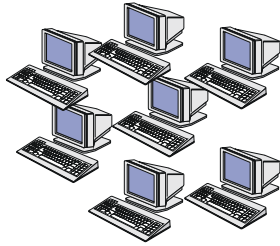

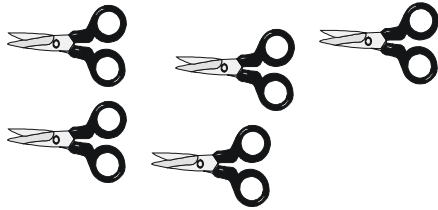

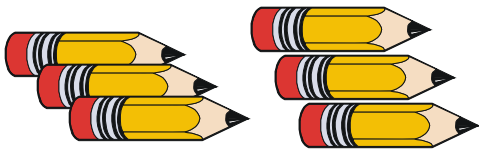

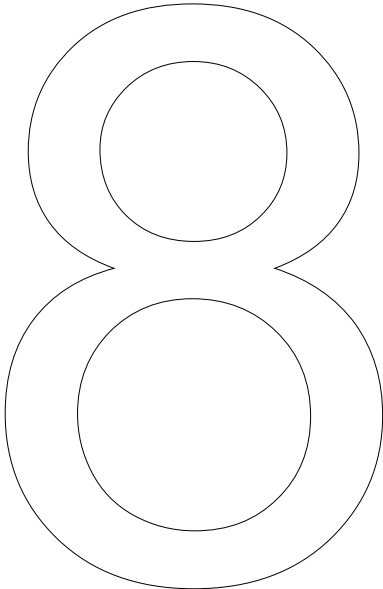

ocho

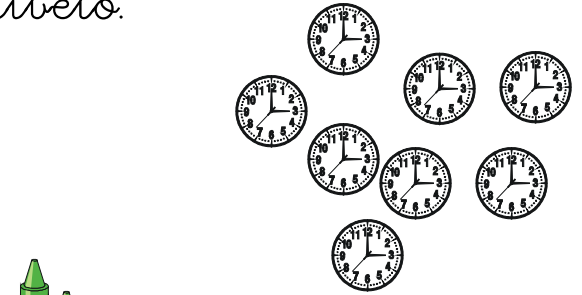

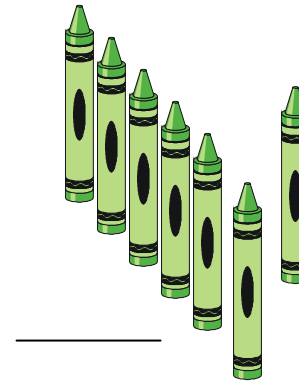

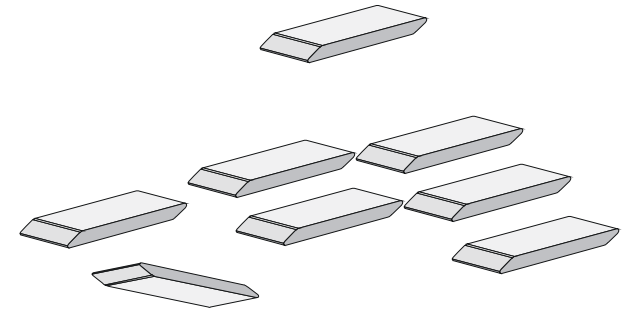

Nombre: Fecha:

Rodea los elementos que te indica el número. Escríbelo.

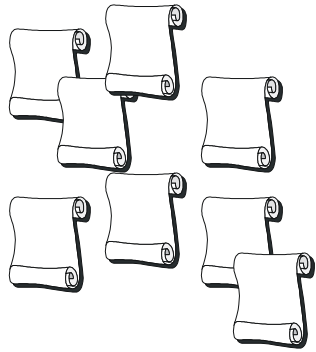

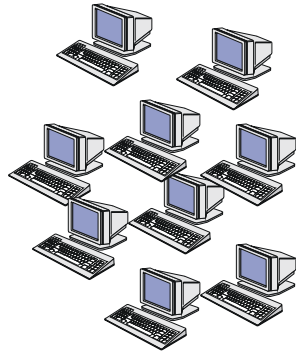

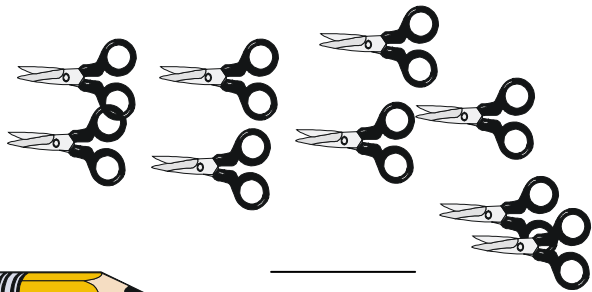

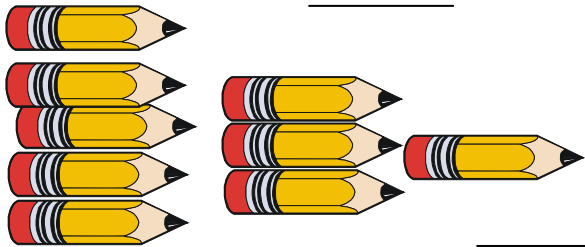

nueve

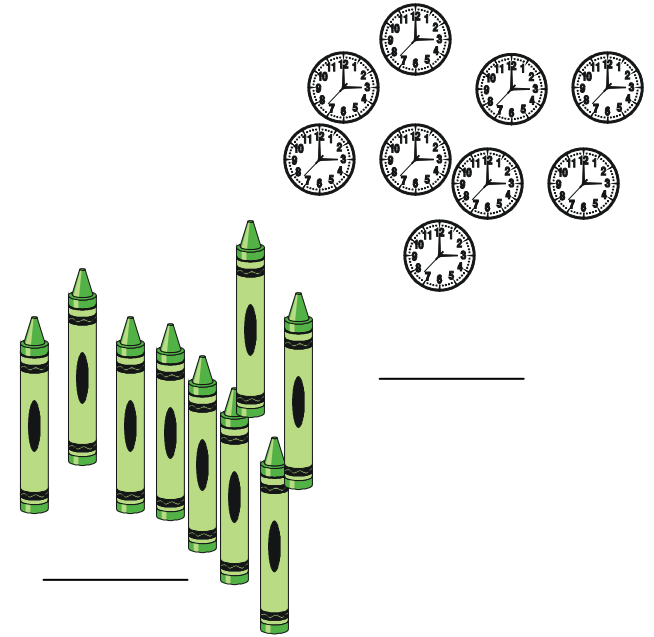

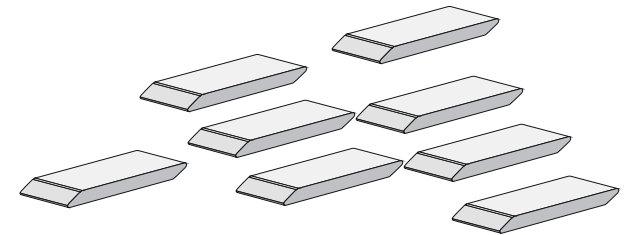

Nombre: Fecha:

• Rodea los elementos que te indica el número. Escríbelo.

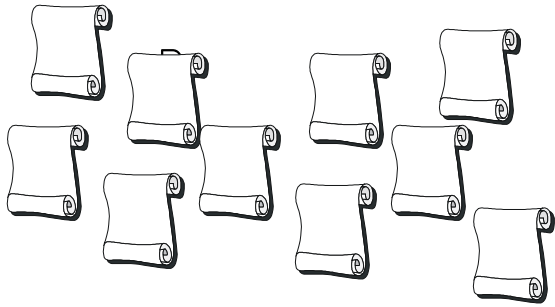

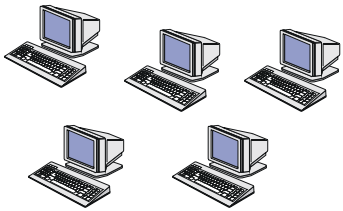

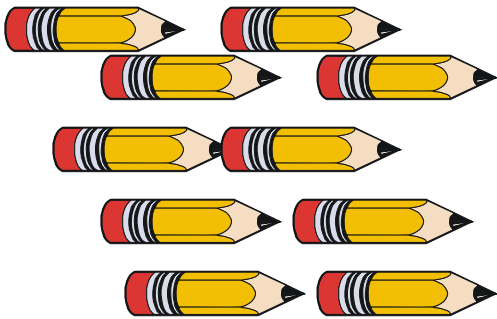

10

diez



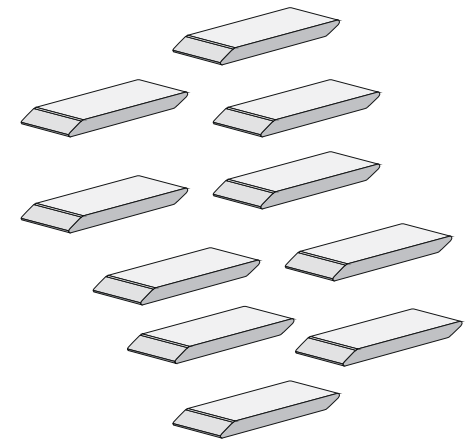

Nombre: Fecha:

● Rodea los elementos que te indica el número. Escríbelo.

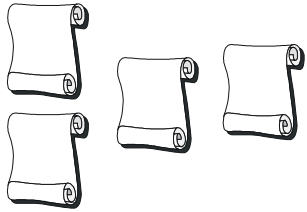

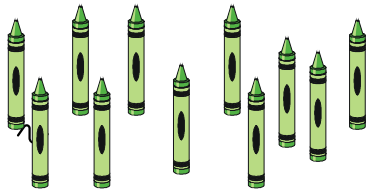

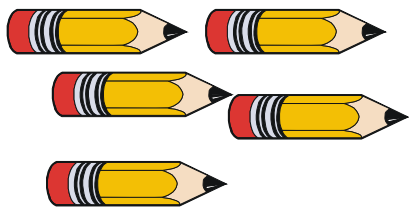



once

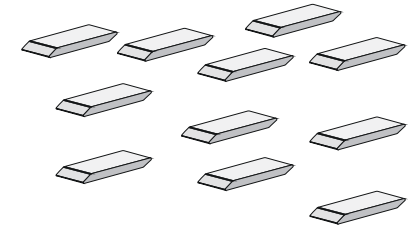

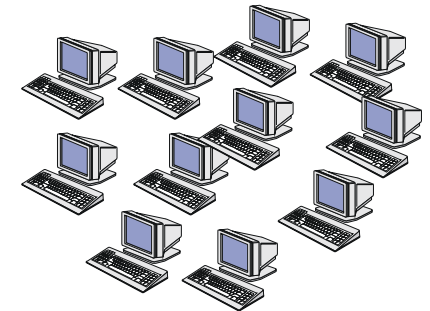



Nombre: Fecha:

● Rodea los elementos que te indica el número. Escríbelo.

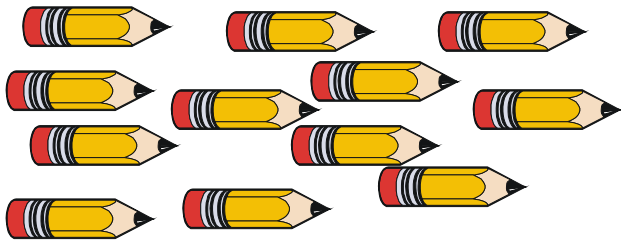
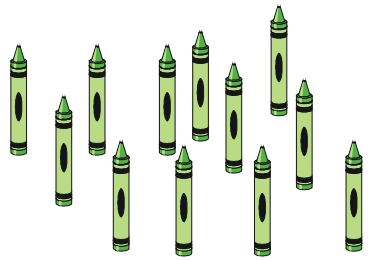
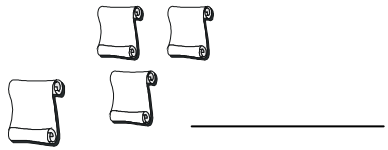

1 2

once

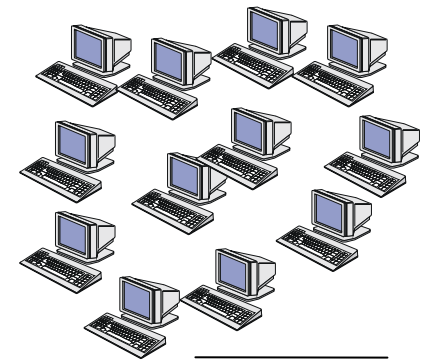
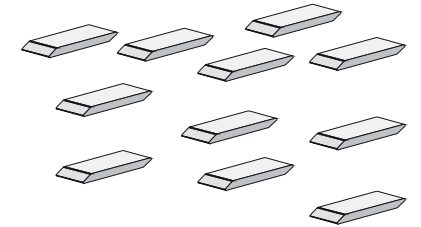

Nombre: Fecha: